

# VS

## Suction Cups with 2.5 Bellows Ø 5 to 88 mm



VS series suction cups with bellows are recommended for gripping products on different planes (wide deflection) where they can replace spring systems, and for gripping spherical or cylindrical objects gripped at an angle (ball-joint effect).

- Large deflection (stroke)
- Flexibility

### Materials

**NBR** Nitrile  
**NR** Natural rubber

**SIT5** Translucent silicone  
**STN** Siton® 60 ShoreA  
**STN5** Siton® 50 ShoreA (on request)



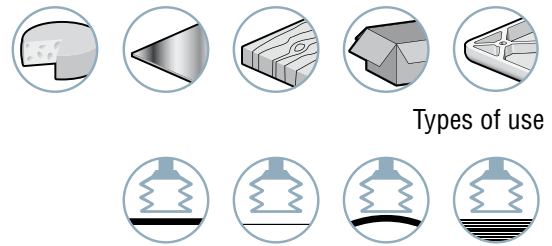

### Industry-specific applications



### Types of use

2 VS

### Suction Cup Properties

	Ø (mm)	 (cm <sup>3</sup> )	 (N) <sup>(1)</sup>	 R <sub>min</sub> (mm)	NBR	SIT5	NR	STN <sup>(2)</sup>
VS 5	5	0.04	0.5	8	VS5NBR	VS5SIT5	-	VS5STN
VS 6	6	0.04	0.5	8	VS6NBR	VS6SIT5	-	-
VS 7	7	0.0425	0.9	8	VS7NBR	VS7SIT5	-	VS7STN
VS 9	9	0.15	1.1	10	VS9NBR	VS9SIT5	VS9NR	VS9STN
VS 12	12	0.54	2.8	13	VS12NBR	VS12SIT5	VS12NR	VS12STN
VS 14	14	0.975	3.0	15	VS14NBR	VS14SIT5	VS14NR	VS14STN
VS 18	17.5	1.35	4.4	20	VS18NBR	VS18SIT5	VS18NR	VS18STN
VS 20	20	2	4.6	30	VS20NBR	VS20SIT5	VS20NR	VS20STN
VS 25	25	5.4	6.5	30	VS25NBR	VS25SIT5	VS25NR	VS25STN
VS 26	25	6.1	10.8	30	VS26NBR	VS26SIT5	VS26NR	VS26STN
VS 32	32	10	12.1	35	VS32NBR	VS32SIT5	VS32NR	VS32STN
VS 42	42	19.5	20.9	75	VS42NBR	VS42SIT5	VS42NR	VS42STN
VS 52	52	36	28.9	75	VS52NBR	VS52SIT5	VS52NR	VS52STN
VS 62	62	72.5	41.2	75	VS62NBR	VS62SIT5	VS62NR	VS62STN
VS 88	88	165	132.9	100	VS88NBR	VS88SIT5	VS88NR	-

(1) Actual force of the suction cup in use with 65% vacuum and including a safety factor of 2 for horizontal handling.

(2) On request, some models are available in STN5 ( Siton® 50 ShoreA)

### Choice of Fittings





 (Ø)	Group	M3-M	M5-M	M6-M	M8-M	M10-M	G1/8"-F	G1/8"-M	10/32-M	G1/4"-F	G1/4"-M	G3/8"-M	G1/2"-M
5 - 6	1	■	-	-	-	-	-	-	-	-	-	-	-
7 - 25	1	-	■	■	-	-	■	■	□	-	-	-	-
26 - 62	2	-	□	□	□	□	■	■	-	■	■	-	-
88	3	-	-	-	-	□	-	■	-	■	■	□	□

■ Standard available configurations (suction cup + fitting) refer to page 2/44  
□ Additional mounting configurations see page 2/47

Fitting: M = male F = female

### Types of Assembly

COVAL suction cups can be assembled in a wide variety of configurations.

- C**  **Version C** Barbed fitting
- S**  **Version S** Factory-crimped fitting
- V**  **Version V** Removable fitting: (adapter and hollow screw)
- E**  **Version E** Pressed fitting

### Textured Surfaces

For handling objects with a granular or textured gripping surface, use VS suction cups with the VSBM foam strip option (see page 2/59).

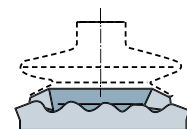

Please specify the part n°. e.g. VS32SIT5IF14  
Refer to page 2/44

### Accessories

To optimize the use of your suction cups, Coval offers a comprehensive range of accessories (nozzle fittings, spring extensions, and feeder systems, etc.), see chapters 4 and 12.

# VS

## Suction Cups with 2.5 Bellows Ø 5 to 88 mm

References - "Suction Cup + Fitting"



2  
VS

Group 1		C				
Ø 5 - 25 mm	THREAD	M3M	M5M	M6M	G1/8"-M	G1/8"-F
	VS5NBR	VS5NBRIMM3C	-	-	-	-
VS5SIT5	VS5SIT5IMM3C	-	-	-	-	-
VS5STN	VS5STNIMM3C	-	-	-	-	-
VS6NBR	VS6NBRIMM3C	-	-	-	-	-
VS6SIT5	VS6SIT5IMM3C	-	-	-	-	-
VS7NBR	-	VS7NBRIMM5C	VS7NBRIMM6C	VS7NBRIM18C	VS7NBRIF18C	
VS7SIT5	-	VS7SIT5IMM5C	VS7SIT5IMM6C	VS7SIT5IM18C	VS7SIT5IF18C	
VS7STN	-	VS7STNIMM5C	VS7STNIMM6C	VS7STNIM18C	VS7STNIF18C	
VS9NBR	-	VS9NBRIMM5C	VS9NBRIMM6C	VS9NBRIM18C	VS9NBRIF18C	
VS9SIT5	-	VS9SIT5IMM5C	VS9SIT5IMM6C	VS9SIT5IM18C	VS9SIT5IF18C	
VS9NR	-	VS9NRIMM5C	VS9NRIMM6C	VS9NRIM18C	VS9NRIF18C	
VS9STN	-	VS9STNIMM5C	VS9STNIMM6C	VS9STNIM18C	VS9STNIF18C	
VS12NBR	-	VS12NBRIMM5C	VS12NBRIMM6C	VS12NBRIM18C	VS12NBRIF18C	
VS12SIT5	-	VS12SIT5IMM5C	VS12SIT5IMM6C	VS12SIT5IM18C	VS12SIT5IF18C	
VS12NR	-	VS12NRIMM5C	VS12NRIMM6C	VS12NRIM18C	VS12NRIF18C	
VS12STN	-	VS12STNIMM5C	VS12STNIMM6C	VS12STNIM18C	VS12STNIF18C	
VS14NBR	-	VS14NBRIMM5C	VS14NBRIMM6C	VS14NBRIM18C	VS14NBRIF18C	
VS14SIT5	-	VS14SIT5IMM5C	VS14SIT5IMM6C	VS14SIT5IM18C	VS14SIT5IF18C	
VS14NR	-	VS14NRIMM5C	VS14NRIMM6C	VS14NRIM18C	VS14NRIF18C	
VS14STN	-	VS14STNIMM5C	VS14STNIMM6C	VS14STNIM18C	VS14STNIF18C	
VS18NBR	-	VS18NBRIMM5C	VS18NBRIMM6C	VS18NBRIM18C	VS18NBRIF18C	
VS18SIT5	-	VS18SIT5IMM5C	VS18SIT5IMM6C	VS18SIT5IM18C	VS18SIT5IF18C	
VS18NR	-	VS18NRIMM5C	VS18NRIMM6C	VS18NRIM18C	VS18NRIF18C	
VS18STN	-	VS18STNIMM5C	VS18STNIMM6C	VS18STNIM18C	VS18STNIF18C	
VS20NBR	-	VS20NBRIMM5C	VS20NBRIMM6C	VS20NBRIM18C	VS20NBRIF18C	
VS20SIT5	-	VS20SIT5IMM5C	VS20SIT5IMM6C	VS20SIT5IM18C	VS20SIT5IF18C	
VS20NR	-	VS20NRIMM5C	VS20NRIMM6C	VS20NRIM18C	VS20NRIF18C	
VS20STN	-	VS20STNIMM5C	VS20STNIMM6C	VS20STNIM18C	VS20STNIF18C	
VS25NBR	-	VS25NBRIMM5C	VS25NBRIMM6C	VS25NBRIM18C	VS25NBRIF18C	
VS25SIT5	-	VS25SIT5IMM5C	VS25SIT5IMM6C	VS25SIT5IM18C	VS25SIT5IF18C	
VS25NR	-	VS25NRIMM5C	VS25NRIMM6C	VS25NRIM18C	VS25NRIF18C	
VS25STN	-	VS25STNIMM5C	VS25STNIMM6C	VS25STNIM18C	VS25STNIF18C	

Group 2		C		E		V			
Ø 26 - 62 mm	THREAD	G1/4"-M	G1/4"-F	G1/4"-M	G1/4"-F	G1/8"-M	G1/8"-F	G1/4"-M	G1/4"-F
	VS26NBR	VS26NBRIM14C	VS26NBRIF14C	VS26NBRIM14	VS26NBRIF14	VS26NBRIM18V	VS26NBRIF18V	VS26NBRIM14V	VS26NBRIF14V
VS26SIT5	VS26SIT5IM14C	VS26SIT5IF14C	VS26SIT5IM14	VS26SIT5IF14	VS26SIT5IM18V	VS26SIT5IF18V	VS26SIT5IM14V	VS26SIT5IF14V	
VS26NR	VS26NRIM14C	VS26NRIF14C	VS26NRIM14	VS26NRIF14	VS26NRIM18V	VS26NRIF18V	VS26NRIM14V	VS26NRIF14V	
VS26STN	VS26STNIM14C	VS26STNIF14C	VS26STNIM14	VS26STNIF14	VS26STNIM18V	VS26STNIF18V	VS26STNIM14V	VS26STNIF14V	
VS32NBR	VS32NBRIM14C	VS32NBRIF14C	VS32NBRIM14	VS32NBRIF14	VS32NBRIM18V	VS32NBRIF18V	VS32NBRIM14V	VS32NBRIF14V	
VS32SIT5	VS32SIT5IM14C	VS32SIT5IF14C	VS32SIT5IM14	VS32SIT5IF14	VS32SIT5IM18V	VS32SIT5IF18V	VS32SIT5IM14V	VS32SIT5IF14V	
VS32NR	VS32NRIM14C	VS32NRIF14C	VS32NRIM14	VS32NRIF14	VS32NRIM18V	VS32NRIF18V	VS32NRIM14V	VS32NRIF14V	
VS32STN	VS32STNIM14C	VS32STNIF14C	VS32STNIM14	VS32STNIF14	VS32STNIM18V	VS32STNIF18V	VS32STNIM14V	VS32STNIF14V	
VS42NBR	VS42NBRIM14C	VS42NBRIF14C	VS42NBRIM14	VS42NBRIF14	VS42NBRIM18V	VS42NBRIF18V	VS42NBRIM14V	VS42NBRIF14V	
VS42SIT5	VS42SIT5IM14C	VS42SIT5IF14C	VS42SIT5IM14	VS42SIT5IF14	VS42SIT5IM18V	VS42SIT5IF18V	VS42SIT5IM14V	VS42SIT5IF14V	
VS42NR	VS42NRIM14C	VS42NRIF14C	VS42NRIM14	VS42NRIF14	VS42NRIM18V	VS42NRIF18V	VS42NRIM14V	VS42NRIF14V	
VS42STN	VS42STNIM14C	VS42STNIF14C	VS42STNIM14	VS42STNIF14	VS42STNIM18V	VS42STNIF18V	VS42STNIM14V	VS42STNIF14V	
VS52NBR	VS52NBRIM14C	VS52NBRIF14C	VS52NBRIM14	VS52NBRIF14	VS52NBRIM18V	VS52NBRIF18V	VS52NBRIM14V	VS52NBRIF14V	
VS52SIT5	VS52SIT5IM14C	VS52SIT5IF14C	VS52SIT5IM14	VS52SIT5IF14	VS52SIT5IM18V	VS52SIT5IF18V	VS52SIT5IM14V	VS52SIT5IF14V	
VS52NR	VS52NRIM14C	VS52NRIF14C	VS52NRIM14	VS52NRIF14	VS52NRIM18V	VS52NRIF18V	VS52NRIM14V	VS52NRIF14V	
VS52STN	VS52STNIM14C	VS52STNIF14C	VS52STNIM14	VS52STNIF14	VS52STNIM18V	VS52STNIF18V	VS52STNIM14V	VS52STNIF14V	
VS62NBR	VS62NBRIM14C	VS62NBRIF14C	VS62NBRIM14	VS62NBRIF14	VS62NBRIM18V	VS62NBRIF18V	VS62NBRIM14V	VS62NBRIF14V	
VS62SIT5	VS62SIT5IM14C	VS62SIT5IF14C	VS62SIT5IM14	VS62SIT5IF14	VS62SIT5IM18V	VS62SIT5IF18V	VS62SIT5IM14V	VS62SIT5IF14V	
VS62NR	VS62NRIM14C	VS62NRIF14C	VS62NRIM14	VS62NRIF14	VS62NRIM18V	VS62NRIF18V	VS62NRIM14V	VS62NRIF14V	
VS62STN	VS62STNIM14C	VS62STNIF14C	VS62STNIM14	VS62STNIF14	VS62STNIM18V	VS62STNIF18V	VS62STNIM14V	VS62STNIF14V	

Group 3		V			S	
Ø 88 mm	THREAD	G1/8"-M	G1/4"-M	G1/4"-F	G1/4"-M	G1/4"-F
	VS88NBR	VS88NBRIM18V	VS88NBRIM14V	VS88NBRIF14V	VS88NBRIM14	VS88NBRIF14
VS88SIT5	VS88SIT5IM18V	VS88SIT5IM14V	VS88SIT5IF14V	VS88SIT5IM14	VS88SIT5IF14	
VS88NR	VS88NRIM18V	VS88NRIM14V	VS88NRIF14V	VS88NRIM14	VS88NRIF14	

Additional mounting configurations are available (see page 2/47). For standard configurations (suction cup+fitting), the C and V versions are delivered unassembled.

# VS

## Suction Cups with 2.5 Bellows Ø 5 to 88 mm

Dimensions - "Suction Cup + Fitting"

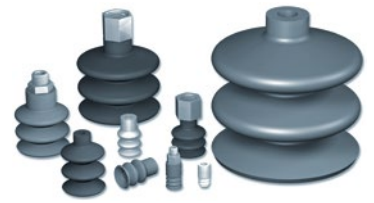

VS 2

**VS 5 - 9    Group 1**                      **VS 12 - 25    Group 1**

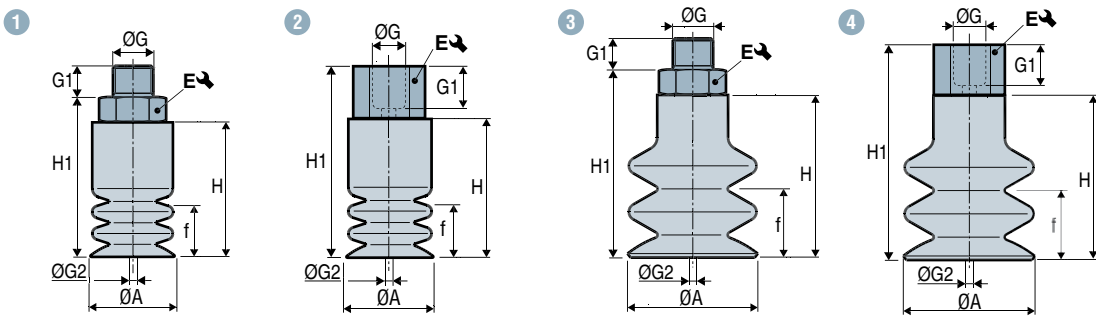

**VS 26 - 62    Group 2**                      **VS 88    Group 3**

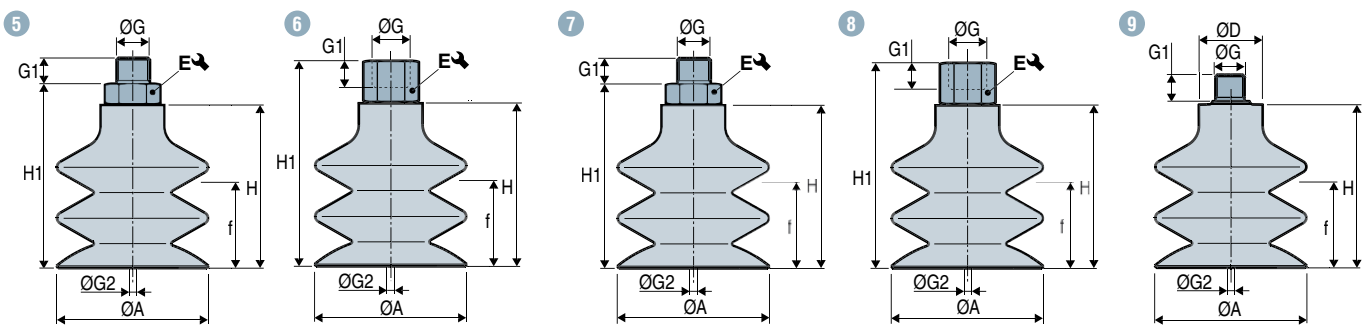

Group 1	Diagram	ØA	ØD	f <sup>(1)</sup>	H	H1	ØG	G1	ØG2 <sup>(2)</sup>	E ↺	⊃(g)	
Ø 5 - 25 mm	VS5---IMM3C	1	5	-	3	13.5	15.5	M3-M	3	1.4	5	0.7
	VS6---IMM3C	1	6	-	3	13.2	15.2	M3-M	3	1.4	5	0.7
	VS7---IMM5C	1	7	-	3	13.5	18.5	M5-M	4.5	2.5	7	3.5
	VS7---IMM6C	1	7	-	3	13.5	18.5	M6-M	5	3.5	7	3.1
	VS7---IM18C	1	7	-	3	13.5	19.5	G1/8"-M	7.5	3.5	14	4.5
	VS7---IF18C	2	7	-	3	13.5	25.5	G1/8"-F	8	3.5	14	4.4
	VS9---IMM5C	1	9	-	3	15	20	M5-M	4.5	2.5	7	3.7
	VS9---IMM6C	1	9	-	3	15	20	M6-M	5	3.5	7	3.3
	VS9---IM18C	1	9	-	3	15	21	G1/8"-M	7.5	3.5	14	4.8
	VS9---IF18C	2	9	-	3	15	27	G1/8"-F	8	3.5	14	4.6
	VS12---IMM5C	3	12	-	7	21	26	M5-M	4.5	2.5	7	3.2
	VS12---IMM6C	3	12	-	7	21	26	M6-M	5	3.5	7	3.8
	VS12---IM18C	3	12	-	7	21	27	G1/8"-M	7.5	3.5	14	5.2
	VS12---IF18C	4	12	-	7	21	33	G1/8"-F	8	3.5	14	5.1
	VS14---IMM5C	3	14	-	10	23	28	M5-M	4.5	2.5	7	4.6
	VS14---IMM6C	3	14	-	10	23	28	M6-M	5	3.5	7	4.2
	VS14---IM18C	3	14	-	10	23	29	G1/8"-M	7.5	3.5	14	5.6
	VS14---IF18C	4	14	-	10	23	35	G1/8"-F	8	3.5	14	5.5
	VS18---IMM5C	3	17.5	-	10	23	28	M5-M	4.5	2.5	7	5.1
	VS18---IMM6C	3	17.5	-	10	23	28	M6-M	5	3.5	7	4.7
	VS18---IM18C	3	17.5	-	10	23	29	G1/8"-M	7.5	3.5	14	6.1
	VS18---IF18C	4	17.5	-	10	23	35	G1/8"-F	8	3.5	14	6
	VS20---IMM5C	3	20	-	10	23	28	M5-M	4.5	2.5	7	5.5
	VS20---IMM6C	3	20	-	10	23	28	M6-M	5	3.5	7	5.1
	VS20---IM18C	3	20	-	10	23	29	G1/8"-M	7.5	3.5	14	6.5
VS20---IF18C	4	20	-	10	23	35	G1/8"-F	8	3.5	14	6.4	
VS25---IMM5C	3	25	-	20	34	39	M5-M	4.5	2.5	7	7.4	
VS25---IMM6C	3	25	-	20	34	39	M6-M	5	3.5	7	7	
VS25---IM18C	3	25	-	20	34	40	G1/8"-M	7.5	3.5	14	8.4	
VS25---IF18C	4	25	-	20	34	46	G1/8"-F	8	3.5	14	8.3	

Note: All dimensions are in mm.

(1) f = Deflection of the suction cup. (2) Ø G2 = Ø internal orifice of the fitting.

# VS

## Suction Cups with 2.5 Bellows Ø 5 to 88 mm

### Dimensions - "Suction Cup + Fitting"



Group 2	Diagram	ØA	ØD	f <sup>(1)</sup>	H	H1	ØG	G1	ØG2 <sup>(2)</sup>	E ↘	⊞(g)	
Ø 26 - 62 mm	VS26---IM18V	5	25	-	11	31	35.5	G1/8"-M	6	3.5	13	20.2
	VS26---IF18V	6	25	-	11	31	44	G1/8"-F	7.5	3.5	13	23.5
	VS26---IM14	5	25	-	11	31	35	G1/4"-M	11	4.4	17	14.1
	VS26---IM14C	5	25	-	11	31	39	G1/4"-M	10	7	17	15
	VS26---IM14V	5	25	-	11	31	36	G1/4"-M	8	3.5	17	29.5
	VS26---IF14	6	25	-	11	31	46	G1/4"-F	10	4.4	17	14.7
	VS26---IF14C	6	25	-	11	31	46	G1/4"-F	12	6.9	17	14.3
	VS26---IF14V	6	25	-	11	31	47	G1/4"-F	11	3.5	17	34.1
	VS32---IM18V	5	32	-	14.5	37.5	42	G1/8"-M	6	3.5	13	22.9
	VS32---IF18V	6	32	-	14.5	37.5	50.5	G1/8"-F	7.5	3.5	13	26.2
	VS32---IM14	5	32	-	14.5	37.5	41.5	G1/4"-M	11	4.4	17	16.8
	VS32---IM14C	5	32	-	14.5	37.5	45.5	G1/4"-M	10	7	17	17.7
	VS32---IM14V	5	32	-	14.5	37.5	42.5	G1/4"-M	8	3.5	17	32.2
	VS32---IF14	6	32	-	14.5	37.5	52.5	G1/4"-F	10	4.4	17	17.4
	VS32---IF14C	6	32	-	14.5	37.5	52.5	G1/4"-F	12	6.9	17	17
	VS32---IF14V	6	32	-	14.5	37.5	53.5	G1/4"-F	11	3.5	17	36.8
	VS42---IM18V	5	42	-	22	46	50.5	G1/8"-M	6	3.5	13	32.1
	VS42---IF18V	6	42	-	22	46	59	G1/8"-F	7.5	3.5	13	35.4
	VS42---IM14	5	42	-	22	46	50	G1/4"-M	11	4.4	17	26
	VS42---IM14C	5	42	-	22	46	54	G1/4"-M	10	7	17	26.2
	VS42---IM14V	5	42	-	22	46	51	G1/4"-M	8	3.5	17	41.4
	VS42---IF14	6	42	-	22	46	61	G1/4"-F	10	4.4	17	26.6
	VS42---IF14C	6	42	-	22	46	61	G1/4"-F	12	6.9	17	26.2
	VS42---IF14V	6	42	-	22	46	62	G1/4"-F	11	3.5	17	46
	VS52---IM18V	5	52	-	27	49	53.5	G1/8"-M	6	3.5	13	38.1
	VS52---IF18V	6	52	-	27	49	62	G1/8"-F	7.5	3.5	13	41.4
	VS52---IM14	5	52	-	27	49	53	G1/4"-M	11	4.4	17	32
	VS52---IM14C	5	52	-	27	49	57	G1/4"-M	10	7	17	32.9
	VS52---IM14V	5	52	-	27	49	54	G1/4"-M	8	3.5	17	47.4
	VS52---IF14	6	52	-	27	49	64	G1/4"-F	10	4.4	17	32.6
	VS52---IF14C	6	52	-	27	49	64	G1/4"-F	12	6.9	17	32.2
	VS52---IF14V	6	52	-	27	49	65	G1/4"-F	11	3.5	17	52
VS62---IM18V	5	62	-	31	55	59.5	G1/8"-M	6	3.5	13	51	
VS62---IF18V	6	62	-	31	55	68	G1/8"-F	7.5	3.5	13	54.3	
VS62---IM14	5	62	-	31	55	59	G1/4"-M	11	4.4	17	44.9	
VS62---IM14C	5	62	-	31	55	63	G1/4"-M	10	7	17	45.8	
VS62---IM14V	5	62	-	31	55	60	G1/4"-M	8	3.5	17	60.3	
VS62---IF14	6	62	-	31	55	70	G1/4"-F	10	4.4	17	45.5	
VS62---IF14C	6	62	-	31	55	70	G1/4"-F	12	6.9	17	45.1	
VS62---IF14V	6	62	-	31	55	71	G1/4"-F	11	3.5	17	65	

### Group 3

Ø 88 mm	VS88---IM18V	9	88	25	48.5	87.5	-	G1/8"-M	8	6	-	142.8
	VS88---IM14	7	88	-	48.5	87.5	93.5	G1/4"-M	11	8	21	153.4
	VS88---IM14V	7	88	-	48.5	87.5	92.5	G1/4"-M	8	6	17	163
	VS88---IF14	8	88	-	48.5	87.5	102.5	G1/4"-F	10	8	21	130.8
	VS88---IF14V	8	88	-	48.5	87.5	106.5	G1/4"-F	9	6	17	134.7

Note: All dimensions are in mm.

(1) f = Deflection of the suction cup.

(2) Ø G2 = Ø internal orifice of the fitting.

VS 2

# VS

## Suction Cups with 2.5 Bellows Ø 5 to 88 mm

### Assembly Diagrams

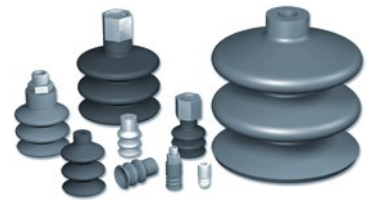

2 VS

#### VS 5 - 25 Group 1

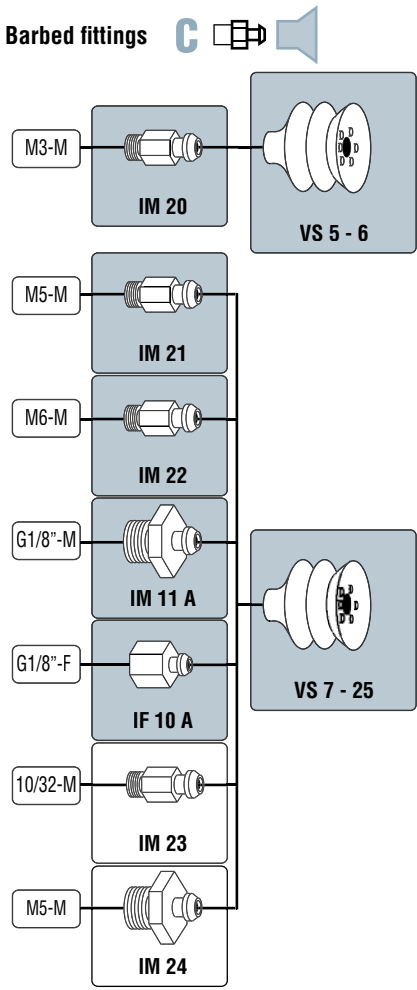

#### VS 26 - 62 Group 2

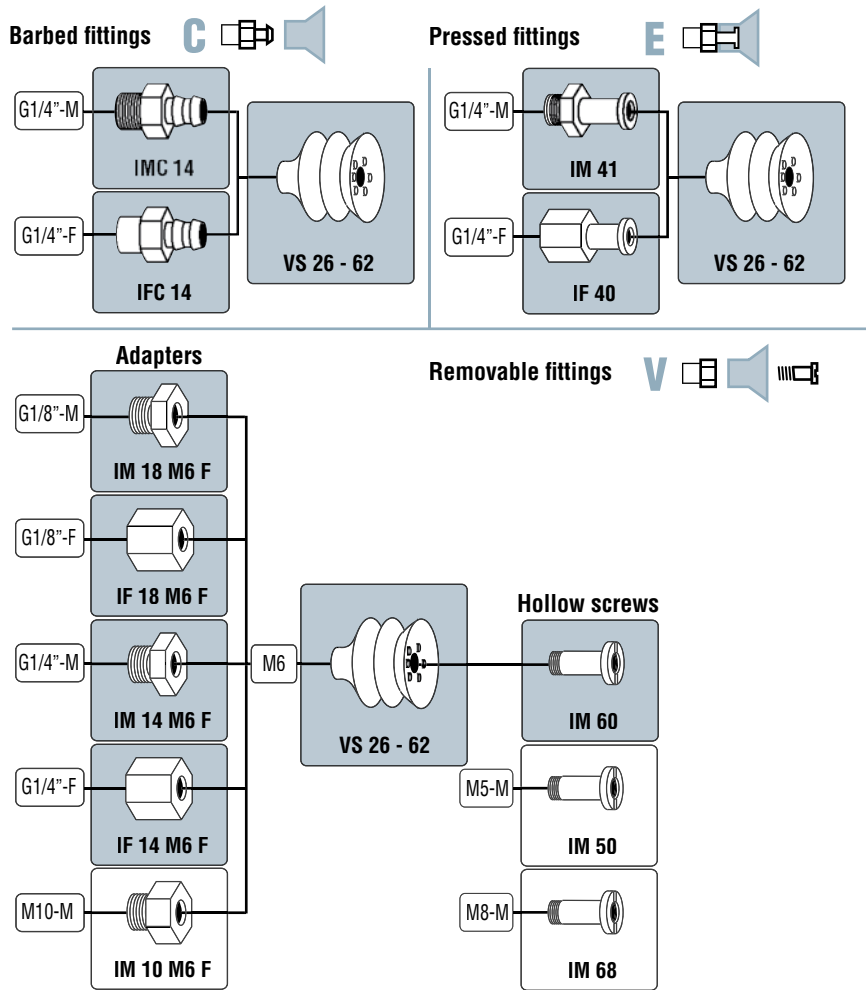

#### VS 88 Group 3

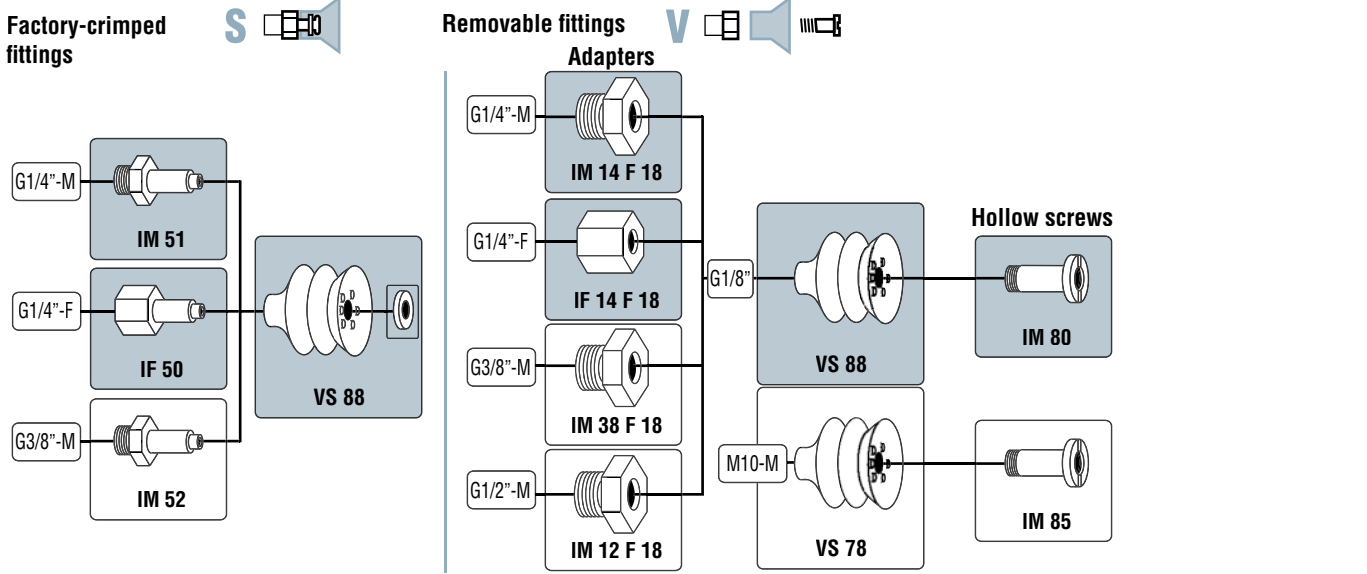

Configurations (suction cup + fitting) refer to page 2/44  
 Non-standard configurations must be ordered in separate part numbers.

Fittings and suction cups dimension: see page 2/48.



#### Suction Cups

VS 5 - 25

VS 26 - 62

VS 88

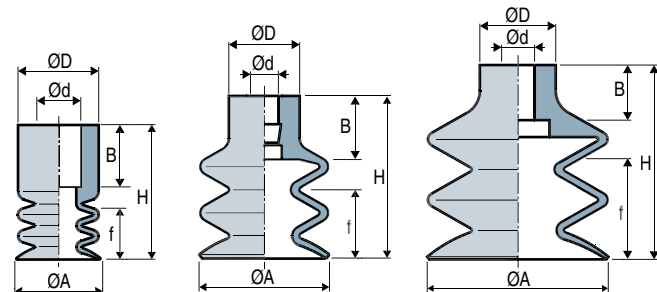

(1) f = Deflection of the suction cup.

	ØA	H	Ød	ØD	f <sup>(1)</sup>	B	⚖️ (g)
VS 5	5	13.5	4	7	3	8	0.3
VS 6	6	13.2	4	7	3	7	0.31
VS 7	7	13.5	4.7	9	3	6	0.42
VS 9	9	15	4.4	9	3	7	0.64
VS 12	12	21	4	10	7	9	1.1
VS 14	14	23	4	10	10	9	1.5
VS 18	17.5	23	4	10	10	9	2
VS 20	20	23	4	10	10	9	2.4
VS 25	25	34	4	10	20	9	4.3
VS 26	25	31	8	16	11	13	6.3
VS 32	32	37.5	8	18	14.5	13	9
VS 42	42	46	8	18	22	13	18.2
VS 52	52	49	8	18	27	13	24.2
VS 62	62	55	8	21	31	13	37.1
VS 88	88	87.5	12	25	48.5	20	119

#### Hollow Screws

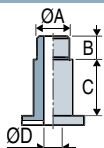

	ØA	B	C	ØD	Material	⚖️ (g)
IM 50	M5-M	5	11	2.8	Nickel-plated brass	7.4
IM 60 <sup>(2) (3)</sup>	M6-M	7	11	3.5	Nickel-plated brass	7.3
IM 68	M8-M	8	11	5.2	Nickel-plated brass	6.5
IM 80	G1/8"-M	8	18	6	Nickel-plated brass	23.8
IM 85	M10x150-M	8	18	6	Nickel-plated brass	23.5

#### Factory-Crimped Fittings

Male - IM

Female - IF

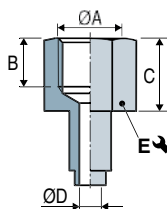
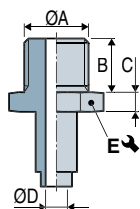

	ØA	B	C	ØD	E	Material	⚖️ (g)
IM 51	G1/4"-M	11	6	8	21	Aluminum	11.8
IF 50	G1/4"-F	10	15	8	21	Aluminum	15.7
IM 52	G3/8"-M	11	6	8	21	Aluminum	14

#### Pressed Fittings

Male - IM

Female - IF

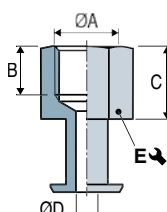
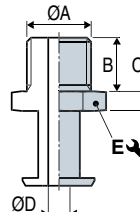

	ØA	B	C	ØD	E	Material	⚖️ (g)
IM 41	G1/4"-M	11	4	4.4	17	Aluminum	7.8
IF 40	G1/4"-F	10	15	4.4	17	Aluminum	8.4

#### Barbed Fittings

Male - IM

Female - IF

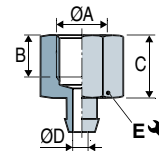
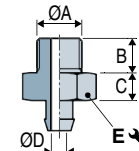

	ØA	B	C	ØD	E	Material	⚖️ (g)
IM 11 A	G1/8"-M	7.5	6	3.5	14	Aluminum	4.1
IMC 14	G1/4"-M	10	8	7	17	Aluminum	8.7
IM 21 <sup>(2)</sup>	M5-M	4.5	5	2.5	7	Nickel-plated brass	3.1
IM 22 <sup>(2)</sup>	M6-M	5	5	3.5	7	Nickel-plated brass	2.7
IM 23	10/32-M	4.5	5	2.5	7	Brass	3
IM 24	M5-M	4.5	2.5	2.5	10	Nickel-plated brass	3.2
IF 10 A	G1/8"-F	8	12	3.5	14	Aluminum	4
IFC 14	G1/4"-F	12	15	6.9	17	Aluminum	8

#### Adapters for Hollow Screws

Male - IM

Female - IF

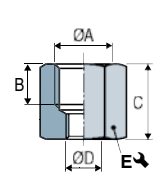
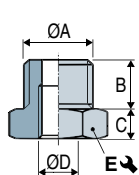

	ØA	B	C	ØD	E	Material	⚖️ (g)
IM 10 M6F	M10-M	7	3.5	M6-F	13	Brass	5.9
IM 12 F18	G1/2"-M	14	6	G1/8"-F	22	Nickel-plated brass	46.8
IM 14 M6F	G1/4"-M	8	5	M6-F	17	Nickel-plated brass	15.9
IM 14 F18	G1/4"-M	8	5	G1/8"-F	17	Nickel-plated brass	10.6
IM 18 M6F	G1/8"-M	6	4.5	M6-F	13	Nickel-plated brass	6.6
IM 38 F18	G3/8"-M	9	5	G1/8"-F	19	Nickel-plated brass	18.8
IF 14 M6F	G1/4"-F	11	16	M6-F	17	Nickel-plated brass	20.5
IF 18 M6F	G1/8"-F	7.5	13	M6-F	13	Nickel-plated brass	9.9
IF 14 F18	G1/4"-F	9	19	G1/8"-F	17	Nickel-plated brass	20.2

The values represent the average characteristics of our products.

(2) Flow restrictor version available: orifice calibrated to reduce leaks when used with a multi-cup gripper (see page 4/9)

(3) Available in stainless steel

Note: All dimensions are in mm.